



HÖFLER

HELIX 400

CYLINDRICAL GEAR TECHNOLOGY – GRINDING MACHINES



KLINGELBERG

Innovative Cylindrical Gear Grinding for Varied Requirements

All around the world, manufacturers of gears and transmissions ensure their leading edge in gear machining with innovative solutions by Klingelberg. High research and development standards, a global service network, and an in-house application engineering service ensure a leadership position – now and in the years to come – thanks to our decades-long expertise and high innovation capacity.

The [Höfler Cylindrical Gear Technology](#) division makes economical, high-precision production of cylindrical gears a reality for customers, with a portfolio that includes cylindrical gear grinding machines for generating grinding, profile grinding, and internal gear grinding, among others. A key factor in the successful completion of each work step is the [Gear Production](#) software, providing optimal process control and extreme ease-of-operation to guarantee maximum efficiency in the daily production routine. Klingelberg also consistently strives to develop innovations and solutions to enhance productivity – and sets the same standard for measuring technology. Machine tool networking with the [Klingelberg Precision Measuring Centers](#) creates a digital process and quality control system within the [Closed Loop concept](#). Klingelberg also offers individual services. In addition to machine maintenance and repair, a number of upgrade options and add-on functions are available.

Höfler cylindrical gear machines are developed with real-world applications in mind and satisfy a whole host of application industry requirements. Customers include contract gear manufacturers and gearbox manufacturers in the aviation, automotive, mining, construction, industrial gearbox, maritime drive technology, and wind power industries.



Höfler HELIX 400 cylindrical gear grinding machine with ergonomically designed enclosure

Exceptional Concepts in the Gearing Process

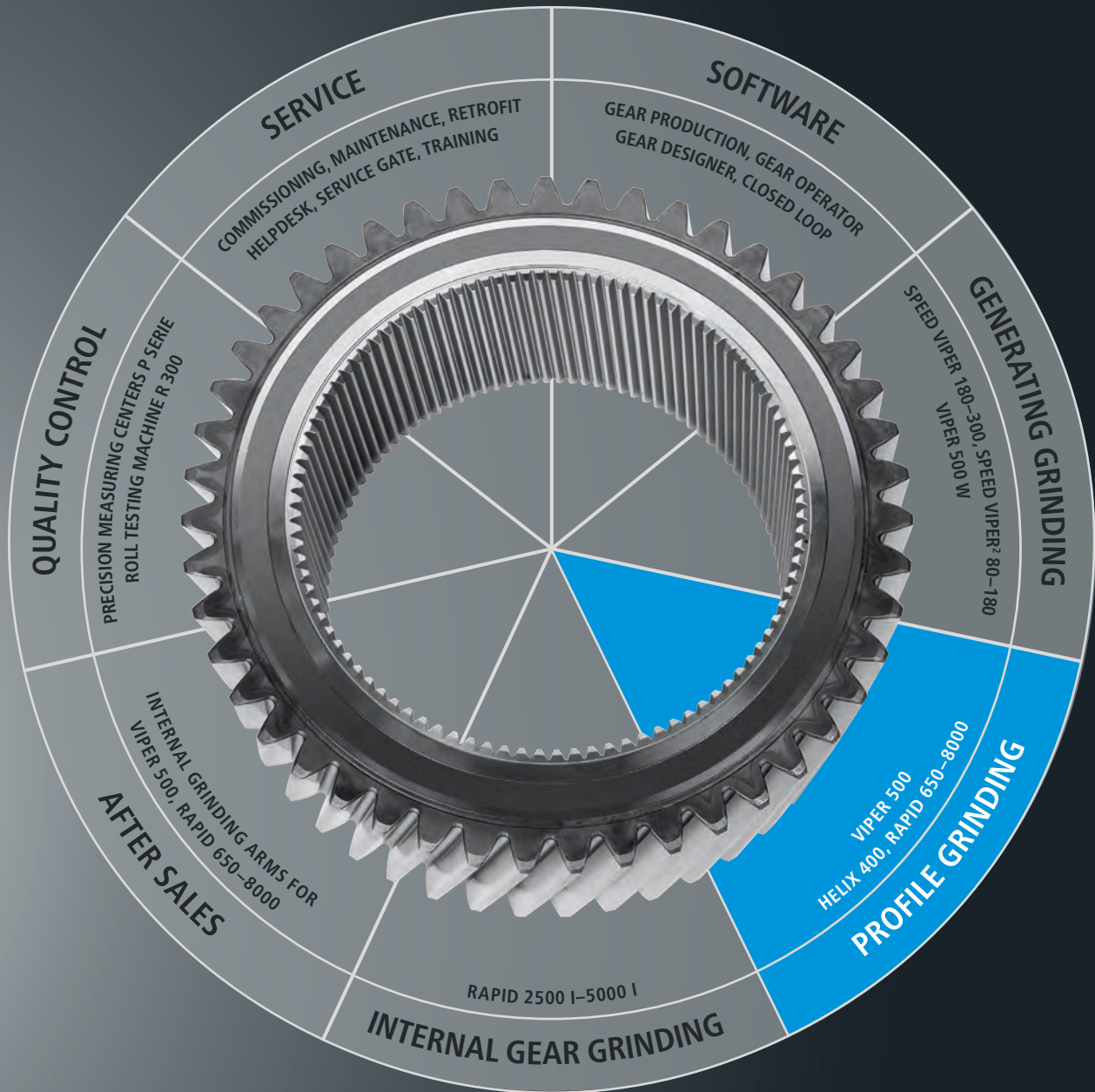

OUTSTANDING GRINDING TECHNOLOGY

Leading Technology for a Flexible, Efficient Production Process

The HELIX 400 cylindrical gear grinding machine is designed for **component diameters up to 400 mm** and is optimally suited for **small to medium-sized batches**. Beside the standard configuration and to suit specific requirements the machine is also available in additional variants: **small grinding wheels for custom jobs (K-/KK-/SK-Variants)** and **multiple-wheel technology (KK-/SK-Variants)**.

The grinding head with infeed axis is mounted on a machine bed made of temperature-stable polymer concrete. The grinding head of a HELIX-machine is mounted on an additional swiveling axis.

Owing to the low workpiece weights relative to the other machine axes, the workpiece moves vertically, synchronously with the counter support. This axis arrangement makes for an extremely compact and space-saving machine configuration overall. The workpiece is conveniently accessible, and the load height for workpiece changes is ergonomically programmable. Moreover, the gear teeth can be measured before or after grinding using optional gear checking. This minimizes retooling and setup or waiting times.

- Maximum flexibility thanks to various grinding spindle sizes with the variants K/KK/SK
- Machine bed made of temperature-stable polymer concrete
- Ergonomically compact and easily accessible
- Maximum efficiency thanks to reliable automation
- Uncompromising accuracy thanks to an integrated inspection system (optional)
- Minimal retooling and setup time

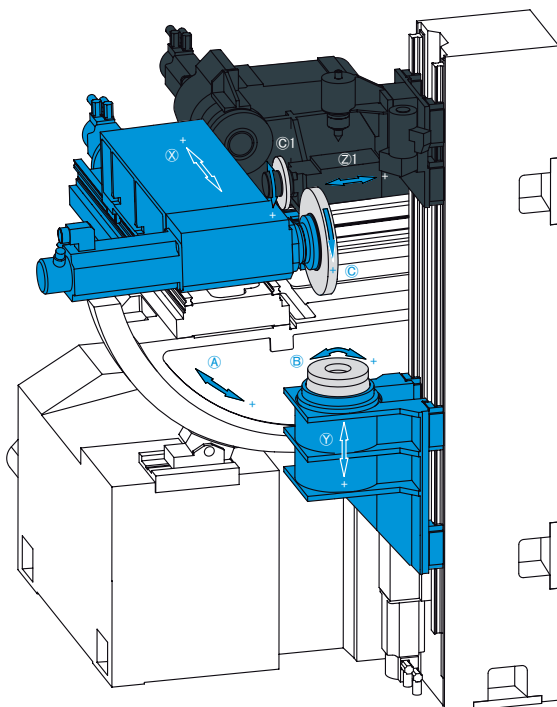

HELIX 400 axis schematic

CNC Axes

X	Grinding slide
Y	Lifting slide
B	Machine table
A	Helix angle
Z1	Dressing slide
C	Controlled grinding spindle drive
C1	Dressing role drive

The Right Machine Configuration for Every Requirement

HELIX 400



Profile Grinding

HELIX 400 K

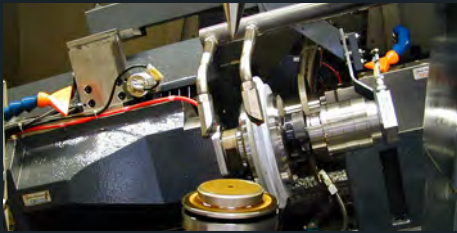

Profile Grinding



Spindle Option K

HELIX 400 KK/SK

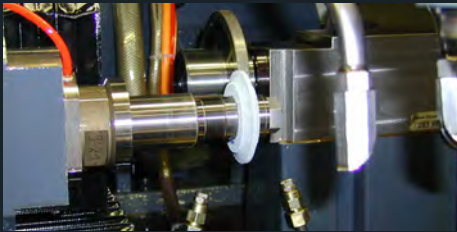

Profile Grinding



Spindle Option KK/SK

HIGHLIGHTS

Maximum Efficiency thanks to an Integrated Automation Solution

Winning features of the HELIX 400 A are its compact configuration and short, precise motion sequences. With automated workpiece feeding in the production steps

- Clamping
- Grinding
- Rotary cleaning

the HELIX 400 A guarantees cost-effective production, ideally designed for economical standard production of gear teeth up to 400 mm in diameter. The HELIX 400 A can also be combined with the optional spindle sizes K/KK/SK.

Result:

Universal applicability, extreme flexibility and particularly short retooling times with maximum precision of the ground gear teeth.

High-tech can be so easy!

"Simplified with Passion" – true to this motto, Klingelberg is driven to provide simple, unconventional solutions to high-tech challenges. A team of engineers and technical experts makes it possible – continually striving to ensure the highest technological standards in application-matched machine designs while maintaining ease of operation.

Case in point: the HELIX type is based on established design concepts that are continuously developed. Klingelberg's success factors include:

- High productivity with the lowest possible per-piece costs and maximum process safety
- Comprehensive services with a broad service network
- Outstanding technical expertise, which Klingelberg passes on to customers in technical seminars



HELIX 400 A is ideally suited for standard production of high-precision toothed gears up to 400 mm in diameter



Intelligent Machine Design

- Compact, thermally stable polymer concrete machine bed with fitted inherently rigid swiveling unit
- Space-saving, compact machine unit for installation even in fluctuating ambient conditions
- Retooling work is quick thanks to the freely accessible working chamber
- Simply designed for quick machine operator training in all mechanical functions

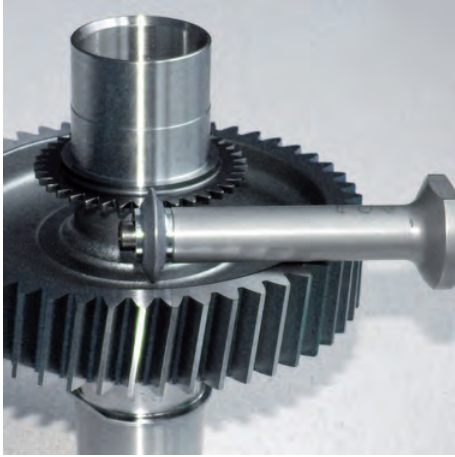

Maximum Flexibility with Grinding Spindle Sizes SK and KK

- A universal range of applications and a large range of grinding wheel diameters without changing spindles
- Spindles with shift-axis permit non-dressable grinding wheels
- Small 7kW grinding spindle for grinding wheels from 20 mm up to 300 mm in diameter for the SK models / small 7kW grinding spindles for grinding wheels from 40 mm up to 300 mm in diameter for the KK models
- Ideal for contract gear manufacturers

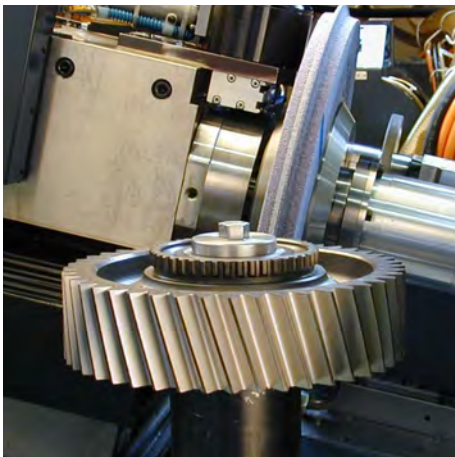

Advanced Grinding Head with AC Servo Grinding Wheel Drive Motor

- Minimal dressing cycles for use of large grinding wheels up to 400 mm in diameter
- Reduced grinding wheel costs and lower risk of grinding burn while also providing high chip removal rates
- Fast, precise, reproducible grinding wheel profiling thanks to low-wear dressing rolls
- Universal dressing rolls for just about any grinding wheel profile



Precise Machine Table Control via Torque Motor Drive

- Precise synchronism and fast positioning movements, as well as highly accurate positioning
- Automatic inertia compensation for every workpiece type change
- Shorter part times and reproducible measuring results during final gear testing
- Wear-free torque motor for high degree of investment safety

HIGHLIGHTS

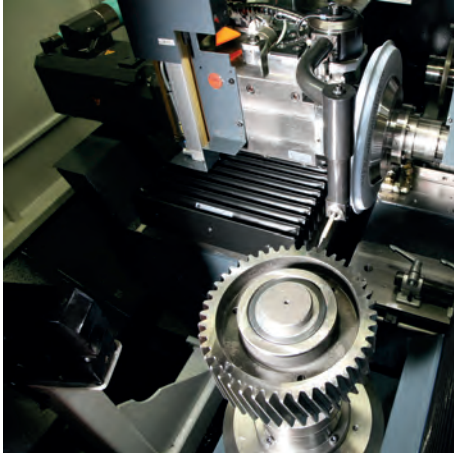

Integrated Inspection System for Maximum Quality Control (Optional)

- Grinding adaptation to the hardening distortion of the workpiece to be ground even before the grinding process begins
- Reliable evaluation of the grinding result as per DIN 3962 or other standards
- Profile, lead and pitch inspection for quality control
- Automatic corrections during the grinding process
- Short retooling and setup times from the elimination of path times or wait times



Reduced Auxiliary Times Thanks to Multi-Wheel Technology (KK-/SK-Variants)

- Efficient grinding process for different gear geometries thanks to a second grinding wheel
- Longer service life of the diamond dressing rolls thanks to fewer profiling passes
- Robust and efficient grinding spindles
- Improved surface accuracy thanks to a finer grinding wheel for finishing

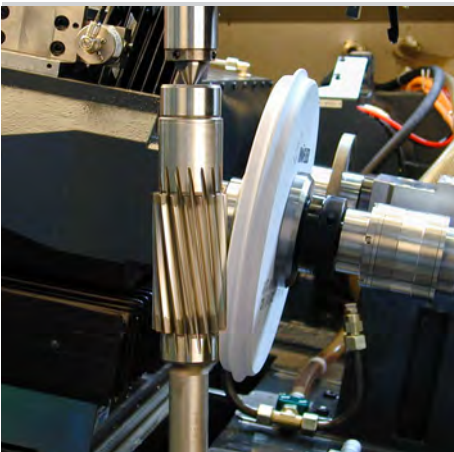

Low Investment Costs and Efficient Production Process

- High machine quality with low acquisition costs
- Short traversing paths for dressing and during the grinding process
- Short downtimes and retooling times
- Fast machine movements
- High stock removal rates
- Hydraulic workpiece clamping (optional)

Numerous Performance Profiles and Custom Options Provide Greater Flexibility in the Grinding Process

Standard Performance Profiles

- Cylindrical wheels and shafts
- Standard modifications in profile and tooth flank
- Automatic 3D collision control
- Siemens electronics, SINUMERIK 840D

Optional Performance Profiles

- Inspecting cylindrical external gearings
- High-speed Grinding (HSG)
- Grinding with CBN grinding wheels
- Multi-grinding wheel technology (KK-/SK-Variants)
- Adaptive Dressing Interval (ADI)
- Dresser Life Control (DLC)
- Grinding and inspecting double helical gearings
- Grinding and inspecting multiple gearings
- Grinding non pre-toothed workpieces
- Grinding extra-wide profiles
- Grinding special profiles
- Grinding and inspecting asymmetrical involutes
- Bias-Controlled Grinding (BCG)
- Grinding and inspecting topological modifications
- Grinding and inspecting spline shafts
- Sharpening hobs and special form cutters (KK-/SK-Variants)



Additional options upon request

USER-FRIENDLY SOFTWARE CONCEPT

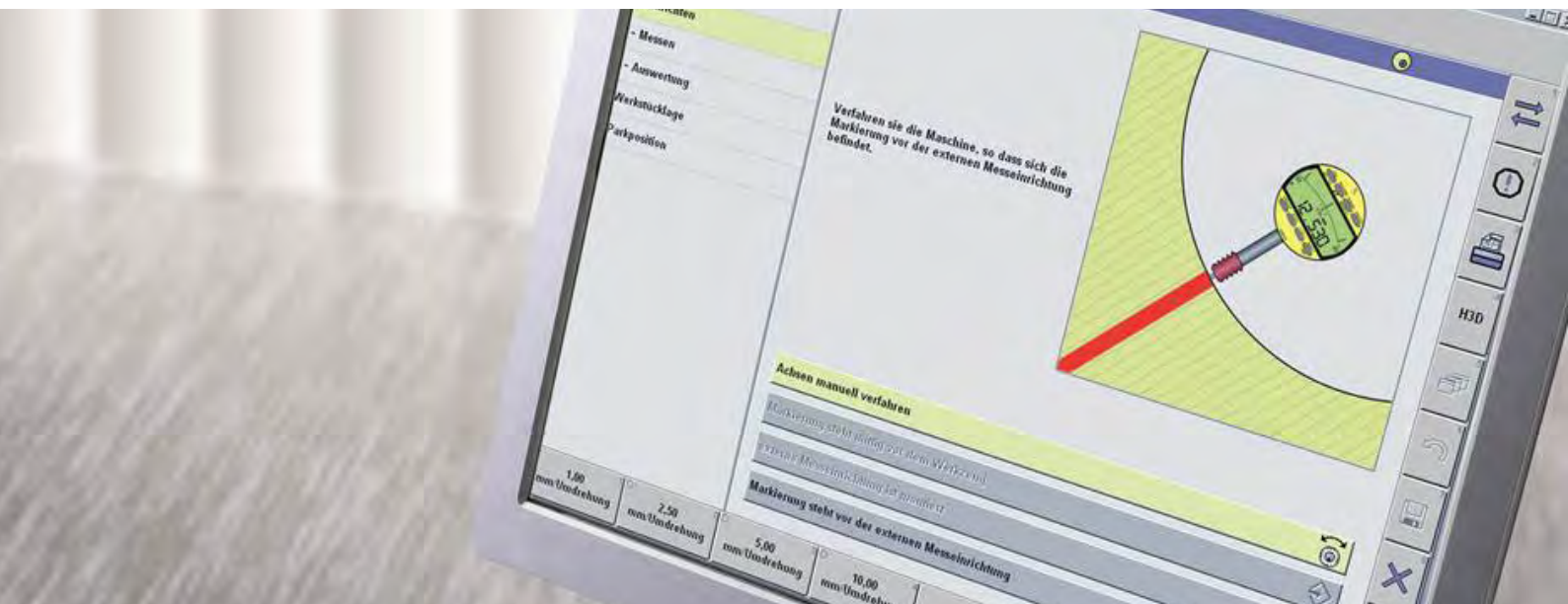

Real Productivity Gains with Gear Production Software

Höfler gear grinding machines are not just distinguished by reliable and advanced hardware. The company's own Gear Production software guarantees convenient machining of even the most complex topographies and ensures maximum efficiency in daily use. Only Gear Production delivers concentrated knowledge of state-of-the-art machining strategies and process sequences right to the user's hands.

And with its numerous options, Gear Production plays an active role in achieving productivity gains. Software modules for high-speed, and adaptive grinding, as well as dressing, were developed to enable significant reductions in production times.

Job Engineering/Pre-analysis:

- Exact process time calculation with original machine data
- 3D analysis of the planned process steps for the working range and possible interference contours
- Tool wear pre-analysis
- Geometric production simulation with 3D analysis of the simulated flank topography
- Calculation and export of optimized tool profiles

Data Input/Navigation:

- Easy navigation through clearly structured interface areas
- Well-organized Microsoft® Windows®-like data management
- Intuitive data input via graphical display
- Clear operator guidance from an automatically generated list of process steps
- Easy-to-understand input of even complex flank topographies and profile forms thanks to numerous context-sensitive wizards
- Various technology wizards for a range of tried-and-tested process variants

Automatic Archiving:

- Flank grinding stock and tooth traces for the blank
- Performance indicators for grinding
- Wear indicators for dressing
- Inspection charts of finished part

Optimal Jobbing Performance – a Sure Thing Thanks to Drive Components with Guaranteed Quality

With the machines from the HELIX range, Klingelberg has developed a modular technology platform that gives contract gear manufacturers in particular a leg up on the competition thanks to maximum process efficiency and unparalleled production quality.

Like no other company, Klingelberg stands for intelligent solution concepts for just about every requirement. Thanks to a unique interplay between technology and software, machining jobs are made significantly easier – allowing for high productivity in mass production while also providing tremendous flexibility in small-batch applications.

With its one-of-a-kind machine design, the new HELIX type provides levels of precision, reliability, and efficiency that are indispensable for contract gear manufacturers and gearbox manufacturers worldwide.



Industrial Gear Units



The industrial gear unit sector comprises many different applications, all of which place great demands on the reliability of the gear wheels. The cylindrical gears for these sectors are often produced by companies specializing in small batch sizes and a variety of products. A stiff machine design and flexible, cost-effective tool systems are the keys to success for ranking among the market leaders in these sectors.

Agriculture



In tractors, cylindrical and planetary gears are used in manual transmissions and counter shaft transmissions as well as planetary gear drives to transmit power to the enormous drive wheels. Because of ever-increasing requirements, these drives must be capable of transmitting increasingly large outputs within limited space. The cylindrical and planetary gears they use must be efficient, smooth-running, and low-maintenance. Reproducible quality in standard production with the fastest possible production times are key requirements in this industry.

Contract Gear Manufacturers



Contract gear manufacturers in particular have to be able to react flexibly to market conditions on a daily basis and produce a whole host of different gear components. From standard solutions to high-tech applications – Klingelberg offers its customers tailor-made machine designs. These are supplemented by comprehensive engineering and other services, including everything from in-house machine certification at Klingelberg, to machine-attendant and software training, right through to production support.

Aviation



Cylindrical gears used in airplanes must meet the highest quality standards in terms of pitch and runout (DIN 1-3) and must also execute rotational movements with absolute reliability. Just as important are other geometrical features such as surface finish, root geometry, rotational error, high strength, and low weight. Special materials, which place extreme demands on tools and processes, are also used frequently.

Railroad Gears



A variety of different applications in automobile manufacturing use cylindrical gears. These include powertrains in rail vehicles, among others, which are subject to very specific requirements such as noise minimization, maximum power transmission and a long service life.

Racing Transmissions



According to the rules of the FIA (Fédération Internationale de l'Automobile), Formula 1 has the highest performance requirements for gears. Extremely high loads at the handling limits – with minimal weight – must be transmitted reliably. A high degree of efficiency and a gear load bearing pattern that is unsusceptible to displacement, as well as the service life, are of critical importance in this application.

TECHNICAL DATA

	HELIX 400	HELIX 400 K	HELIX 400 KK	HELIX 400 SK
Outside diameter toothed gear (max.)	Ø 400 mm			
Toothed gear root circle diameter (min.)	Ø 10 mm			
Axial stroke length	260 mm			
Distance between centers over table (min. – max.)	325 – 745 mm			
Profile height (max.)	35 mm		35/25 mm	35/25/15 mm
Module (min. – max.)	0.5 – approx. 15*			
Pressure angle	no restriction			
Swiveling angle	+/-45°			
Grinding wheel diameter (max.)	Ø 400 mm	Ø 300 mm	Ø 300/100 mm	Ø 300/100/50 mm
Grinding wheel diameter, shoulder (min.)	Ø 174 mm	Ø 80 mm	Ø 80/40 mm	Ø 80/40/15 mm
Grinding wheel width (max.)	45 mm	40 mm	40/25 mm	40/25/15 mm
Grinding spindle drive (max.)	15 kW		7 kW	
Tool slide stroke speed (max.)	6 m/min (12 m/min)**			
Table diameter	Ø 180 mm			
Table load (max.)	100 kg			
Table hole (diameter x depth)	Ø 75 x 40 mm			
Table speed (max.)	85 rpm			
Diamond dressing roll (diameter x depth)	Ø 160 x 13 mm			
Machine dimensions (L x W x H) (including all additional components)	approx. 4,600 x 5,100 x 2,700 mm		approx. 4,600 x 5,100 x 3,000 mm	
Net weight	approx. 10,000 kg			

* Depends on gear geometry

** Available at extra charge

Installation Dimensions

HELIX 400: FRONT VIEW

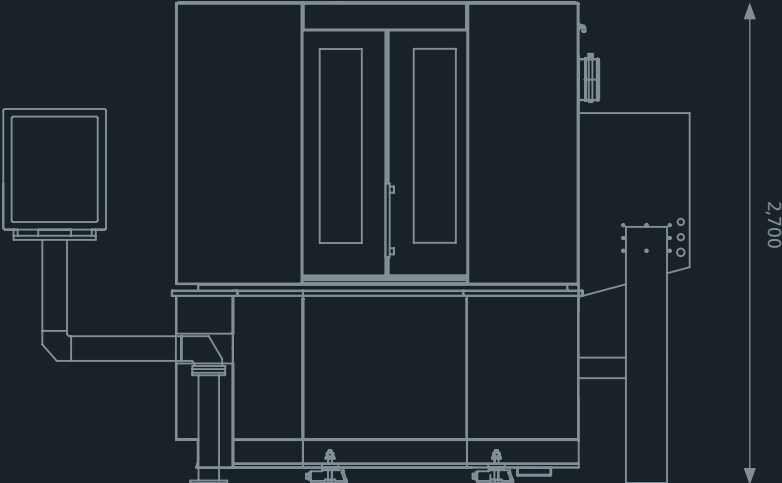

HELIX 400: TOP VIEW

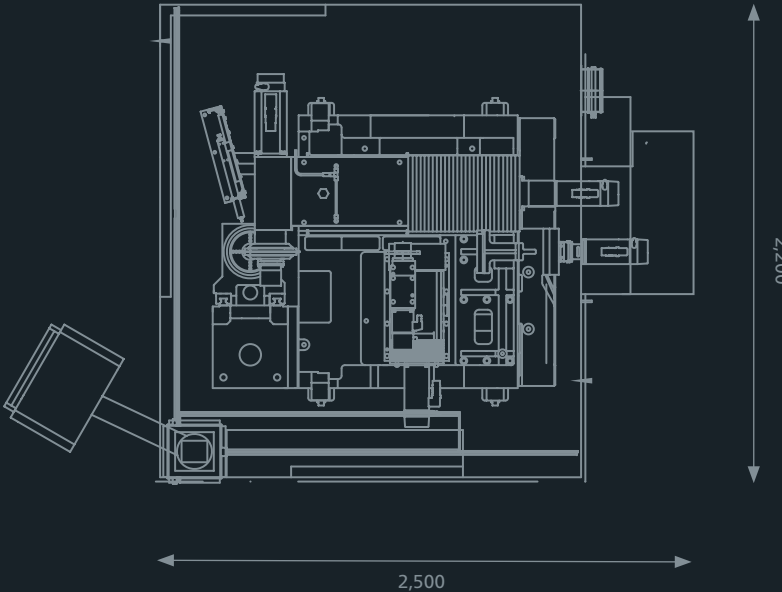

All dimensions in mm

KLINGELNBERG Service

The KLINGELNBERG Group is a world leader in the development and manufacture of machines for bevel gear and cylindrical gear production, and precision measuring centers for gearing and axially symmetrical components, as well as the production of customized high-precision drive components. In addition to the headquarters in Zurich, Switzerland, further development and production facilities are located in Hückeswagen and Ettlingen, Germany.

The company also maintains a presence with Sales and Service offices and numerous marketing agents. On this basis, Klingelberg offers users a comprehensive range of services for all aspects of toothed gear design, manufacturing, and quality inspection. The spectrum includes technical consulting, on-site machine acceptance, operator and software training as well as maintenance contracts.

KLINGELNBERG Solutions

Klingelberg solutions are used in the automotive, commercial vehicle, and aviation industries, as well as in shipbuilding, the wind power industry, and the general transmission manufacturing industry. With numerous R&D engineers around the globe and over 200 registered patents, the company consistently demonstrates its capacity for innovation.

EN 04/2023 - Subject to technical modifications without notice.

FOLLOW US AND STAY UP TO DATE:



KLINGELNBERG AG

Binzmühlestrasse 171
8050 Zürich, Switzerland
Fon: +41 44 278 7979
Fax: +41 44 273 1594

KLINGELNBERG GmbH

Peterstraße 45
42499 Hückeswagen, Germany
Fon: +49 2192 81-0
Fax: +49 2192 81-200

KLINGELNBERG GmbH

Industriestraße 5-9
76275 Ettlingen, Germany
Fon: +49 7243 599-0
Fax: +49 7243 599-165

You can also find your local contact for sales advice at <https://klingelberg.com/en/contact>